

- MANUFACTURED AS STANDARD IN A HIGH STRENGTH LSF GLASS FILLED NYLON
- SINGLE OR TWO BOLT CLEAT FIXING OPTIONS
- SHAPING OF THE CLEAT ENSURES CABLES ARE HELD IN A TREFOIL FORMATION ACROSS THE RANGE
- SHORT CIRCUIT AND MECHANICALLY TESTED TO IEC 61914
- SPACER PIECE ENSURES EQUIDISTANT CABLE SPACING WHILST PROVIDING A LARGE CLAMP RANGE TAKE WHEN USED WITH THE STANDARD TRIDENT CLAMP

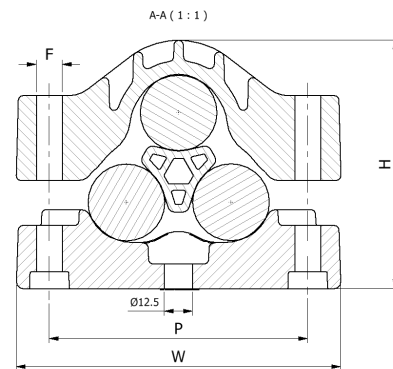

PART NO.	CABLE RANGE (WITH SPACER)		CABLE RANGE (WITHOUT SPACER)		DIMENSIONS (mm)					WEIGHT (g)	CORRESPONDING TRIDENT
	MIN Ø (mm)	MAX Ø (mm)	MIN Ø (mm)	MAX Ø (mm)	W	H	D	P	F		
TR29-41SP	29	34	34	41	144	115	77	114.5	M10	530	TR34-41
TR33-47SP	33	39	39	47	156	127	77	125	M12	618	TR39-47
TR41-54SP	41	45	45	54	172	141	77	145	M12	706	TR45-54

NOTE: REMOVAL OF THE SPACER PIECE CAN BE UTILISED TO PROVIDE A PRODUCT WITH A LARGE RANGE TAKE. REFER TO STANDARD TRIDENT DATA SHEET.

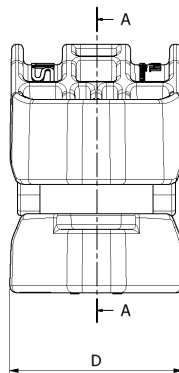
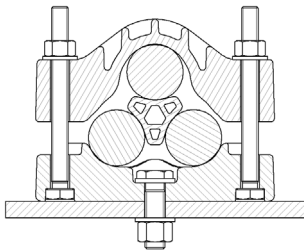

FIXING OPTION 1:
2 x M10/M12 FIXINGS

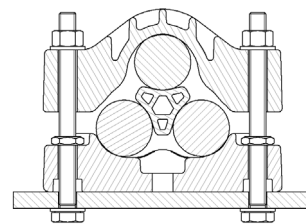

FIXING OPTION 2:
1 x M12 FIXING

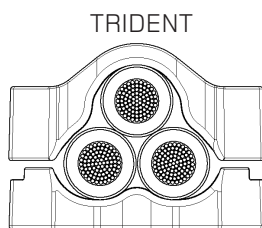

TRIDENT

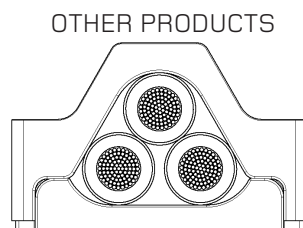

OTHER PRODUCTS

SHAPING OF THE TRIDENT CLAMPS ENSURES CABLES ARE MAINTAINED IN A TRUE TREFOIL FORMATION ACROSS ITS RANGE TAKE, UNLIKE SIMILAR POLYMERIC CLAMPS ON THE MARKET. UNEQUAL TREFOIL FORMATIONS CAN CAUSE ADDITIONAL VOLTAGE DROP.

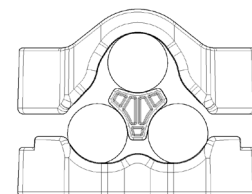

'SP' VARIANTS UTILISE A DISTANCE WEDGE TO INCREASE RANGE TAKE. EQUAL SPACING BETWEEN CABLE IS MAINTAINED.

TESTING SUMMARY

Trident Cleats have been tested in line with the International Standard 'Cable Cleats for Electrical Installations' IEC 61914:2015. Typical results are detailed below, please note that these testing values are maximums and safety factors appropriate to your application should be used:

PROPERTY	CLASSIFICATION CLAUSE IEC 61914	UNITS / CLASSIFICATION	TEST DATA
CLEAT TYPE	6.1.2	NON-METALLIC	-
TEMP. FOR PERMANENT APPLICATION	6.2	°C	-60 - 60
UV RESISTANCE	6.5.1.2	XENON ARC METHOD A	PASS
CORROSION RESISTANCE	6.5.2	N/A	N/A
IMPACT RATING	6.3.5	VERY HEAVY	PASS
FLAME PROPAGATION TEST	10.0, 10.1	APPLICATION TIME $\geq 30s$	PASS
AXIAL LOAD RATING	6.4.3, 9.4	NEWTONS (N)	REFER TO ELLIS
LATERAL LOAD RATING	6.4.2, 9.3	NEWTONS (N)	REFER TO ELLIS
RESISTANCE TO ELECTROMECHANICAL FORCE (SHORT CIRCUIT TESTING)	6.4, 6.4.5, 9.5	CLEATS AT 300MM INTERVALS (WITHSTANDING MORE THAN ONE SHORT CIRCUIT)	106kA (REPORT No. PDL- 21.085.03) CABLE OD= $\phi 36mm$ CABLE SPACING = 50mm

1) SP VARIANTS HAVE A DIFFERENT LOAD WITHSTAND TO STANDARD VARIANTS, REFER TO ELLIS.

2) 'FIXING OPTION 1' S/C STRENGTH IS DERATED. REFER TO ELLIS FOR 'FIXING OPTION 1' SHORT CIRCUIT WITHSTANDS.

3) THE OPERATING TEMPERATURE IS BASED ON THE TEST REQUIREMENTS OF IEC 61914:2015 ONLY.

This data sheet is subject to change without notice. The information provided has been generated in laboratory conditions, as such results in use may vary.